

# RE-HT

# RE-HT

Most suitable for cleaning larger diameter threads.



**IMROBEX**  
Machine Tools International

**ROBERT GENICH**  
Geschäftsführer



IMROBEX GmbH  
Fielenmacherspfad 40  
56626 Andernach  
Germany

Tel.: +49 2632 403 80 79  
Mobil: +49 178 86 85 89 5  
Mail: [info@imrobex.com](mailto:info@imrobex.com)  
Web: [www.imrobex.de](http://www.imrobex.de)  
@imrobex\_gmbh

# RE-HT

HSS

OX  
Oxide



Joint type taps for thread repair and cleaning



- Main usage: For correcting thread flaws, and cleaning out burrs, paint, rust and residual spatters from welding.
- A special geometry and unique cutting edge specification were developed to enable manual repair and cleaning of larger diameter of threads.
- An arbor, cutting edge exchangeable type, can hold a variety of larger taps (M50-M80) that enable thread cleaning.
- By using a longer arbor, cleaning deeper threaded holes becomes possible.
- Using a tap arbor with an exchangeable cutting edge portion is much more economical than a solid tap.

The arbor can facilitate more than one tap size.



## Order of operations

- ① Insert parallel key into the key groove of arbor.
- ② Turn the bolt (M4) with hex hole by using hex wrench (designation 3 mm) and fasten the parallel key firmly.  
\* At the rear side, following operation 1 and 2, fasten the parallel key as well.
- ③ Insert the cutting edge portion into arbor axis reasonably. (Join tenon groove of cutting edge portion to parallel key)
- ④ Set flat washer in the countersink of cutting edge portion.
- ⑤ Fasten the bolt (M10) with hex hole by hex wrench (designation 8 mm) temporarily.
- ⑥ Fasten firmly the cutting edge portion by turning the bolt (M10) with hex hole by using hex wrench, while adjusting the cutting edge portion toward the direction where load is on during tapping.

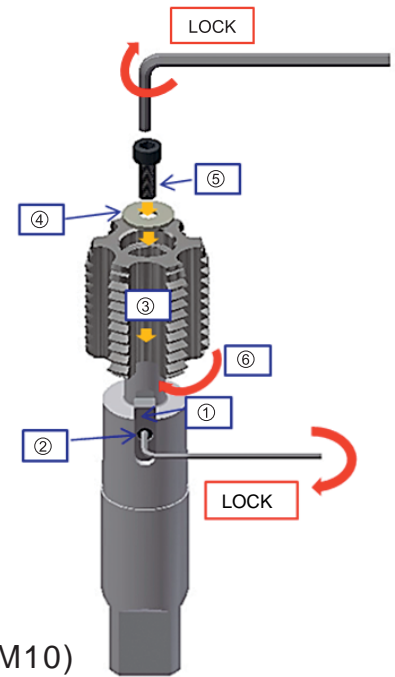

\* When exchanging the cutting edge portion, fasten the arbor firmly in vice and others.

\* Please purchase the hex wrenches from your tool dealer.

## Reference

Fastening torque of fixing screws  
for cutting edge portion (N/m)

Bolt with hex hole	Fastening torque
M10	24

## Remarks during usage

\* RE-HT is specially for Hand use. Don't use it with machine.

- ① Due to combining system, the RE-HT is not recommended for normal thread tapping where there is high load or burden. Please use the RE-HT only for repairing threads or for sweeping thread dusts.
- ② Excessive fastening of bolt with hex hole can cause part deformation or part breakage.

## How to order

- For the first time, please place an order with us for both a cutting edge and an arbor portion.

### [Cutting Edge Portion] Refer to P.4 to P.6

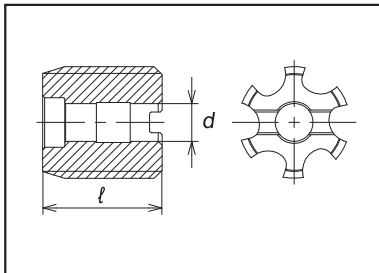

### [Arbor Portion] Refer to P.7

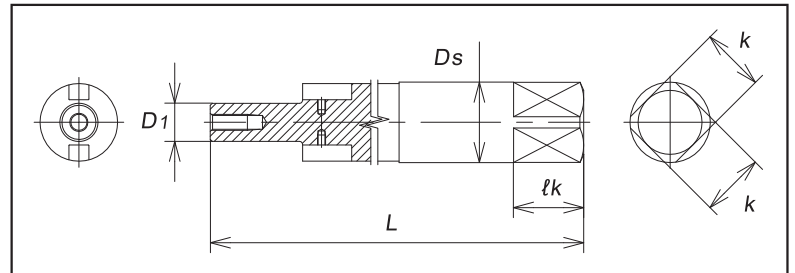

### [After Setup]

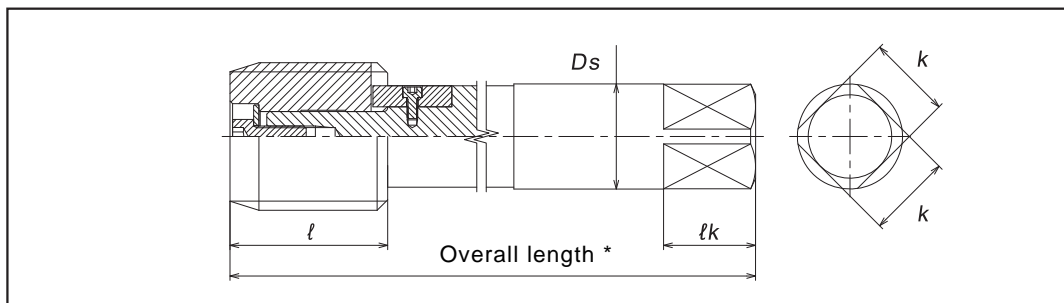

\* There are 3 types of Arbors which can make RE-HT taps to OAL200, 400 and 600 mm after combined with cutting edge portion.

## ■ Example of usage

### [First Order]

Cutting Edge M50X3 (T5050SANEX2) + Arbor (REAB22200) = RE-HT M50X3 L200

- ① After worn out the cutting edge, you can reuse RE-HT M50X3 L200 by purchasing the cutting edge portion M50X3 (T5050SANEX2) only.
- ② You can also use your Arbor (REAB22200) combining with the other size of cutting edge, like M80X1.5 (T5080OANEX2). The overall length is still 200 mm which is the same as before.
- ③ You can change the RE-HT M50X3 L200 into long shank type L600 by combining your cutting edge M50X3 (T5050SANEX2) with the long type arbor (REAB22600).

## ■ Cutting Edge Portion

[TYPE-1]

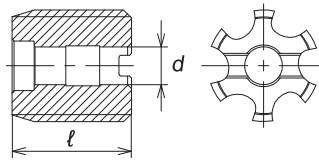

[TYPE-2]

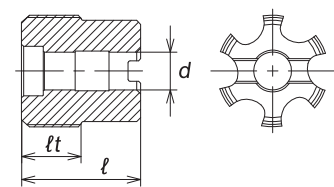

## For Metric Threads

Size	Code	Class	Chamfer	$l$ (mm)	$lt$ (mm)	$d$ (mm)	No. of flutes	Type	Stock
M50X3	T5050SANEX2	ISO2	2P	60	-	22	6	1	△
M50X2	T5050QANEX2	ISO2	2P	60	30	22	6	2	△
M50X1.5	T5052QANEX2								
M52X5	T5052WANEX2	ISO2	2P	60	-	22	6	1	△
M52X4	T5052UANEX2								
M52X3	T5052SANEX2								
M52X2	T5052QANEX2	ISO2	2P	60	30	22	6	2	△
M52X1.5	T5052OANEX2								
M55X4	T5055UANEX2	ISO2	2P	60	-	22	6	1	△
M55X3	T5055SANEX2								
M55X2	T5055QANEX2	ISO2	2P	60	30	22	6	2	△
M55X1.5	T5055OANEX2								
M56X5.5	T5056XANEX2	ISO2	2P	60	-	22	6	1	△
M56X4	T5056UANEX2								
M56X3	T5056SANEX2								
M56X2	T5056QANEX2	ISO2	2P	60	30	22	6	2	△
M56X1.5	T5056OANEX2								
M58X4	T5058UANEX2	ISO2	2P	60	-	22	6	1	△
M58X3	T5058SANEX2								
M58X2	T5058QANEX2	ISO2	2P	60	30	22	6	2	△
M58X1.5	T5058OANEX2								
M60X5.5	T5060XANEX2	ISO2	2P	60	-	22	6	1	△
M60X4	T5060UANEX2								
M60X3	T5060SANEX2								

△ = Made to Order

■ Cutting Edge Portion

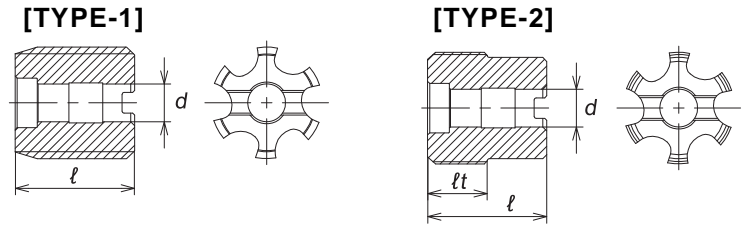

For Metric Threads

Size	Code	Class	Chamfer	ℓ (mm)	ℓt (mm)	d (mm)	No. of flutes	Type	Stock
M60X2	T5060QANEX2	ISO2	2P	60	30	22	6	2	△
M60X1.5	T5060OANEX2								
M62X4	T5062UANEX2	ISO2	2P	60	-	22	6	1	△
M62X3	T5062SANEX2								
M62X2	T5062QANEX2	ISO2	2P	60	30	22	6	2	△
M62X1.5	T5062OANEX2								
M64X6	T5064YANEX2	ISO2	2P	60	-	22	6	1	△
M64X4	T5064UANEX2								
M64X3	T5064SANEX2								
M64X2	T5064QANEX2	ISO2	2P	60	30	22	6	2	△
M64X1.5	T5064OANEX2								
M65X4	T5065UANEX2	ISO2	2P	60	-	22	6	1	△
M65X3	T5065SANEX2								
M65X2	T5065QANEX2	ISO2	2P	60	30	22	6	2	△
M65X1.5	T5065OANEX2								
M68X6	T5068YANEX2	ISO2	2P	60	-	22	6	1	△
M68X4	T5068UANEX2								
M68X3	T5068SANEX2								
M68X2	T5068QANEX2	ISO2	2P	60	30	22	6	2	△
M68X1.5	T5068OANEX2								
M70X6	T5070YANEX2	ISO2	2P	60	-	22	6	1	△
M70X4	T5070UANEX2								
M70X3	T5070SANEX2								

△ = Made to Order

## ■ Cutting Edge Portion

[TYPE-1]

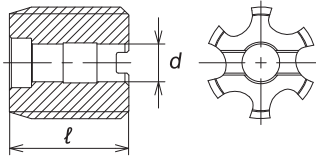

[TYPE-2]

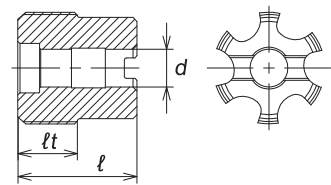

## For Metric Threads

Size	Code	Class	Chamfer	$l$ (mm)	$lt$ (mm)	$d$ (mm)	No. of flutes	Type	Stock
M70X2	T5070QANEX2	ISO2	2P	60	30	22	6	2	△
M70X1.5	T5070OANEX2								
M72X6	T5072YANEX2	ISO2	2P	60	-	22	6	1	△
M72X4	T5072UANEX2								
M72X3	T5072SANEX2								
M72X2	T5072QANEX2	ISO2	2P	60	30	22	6	2	△
M72X1.5	T5072OANEX2								
M75X4	T5075UANEX2	ISO2	2P	60	-	22	6	1	△
M75X3	T5075SANEX2								
M75X2	T5075QANEX2	ISO2	2P	60	30	22	6	2	△
M75X1.5	T5075OANEX2								
M76X6	T5076YANEX2	ISO2	2P	60	-	22	6	1	△
M76X4	T5076UANEX2								
M76X3	T5076SANEX2								
M76X2	T5076QANEX2	ISO2	2P	60	30	22	6	2	△
M76X1.5	T5076OANEX2								
M78X2	T5078QANEX2	ISO2	2P	60	30	22	6	2	△
M80X6	T5080YANEX2	ISO2	2P	60	-	22	6	1	△
M80X4	T5080UANEX2								
M80X3	T5080SANEX2								
M80X2	T5080QANEX2	ISO2	2P	60	30	22	6	2	△
M80X1.5	T5080OANEX2								

△ = Made to Order

## Dimensions and size

### Arbor portion

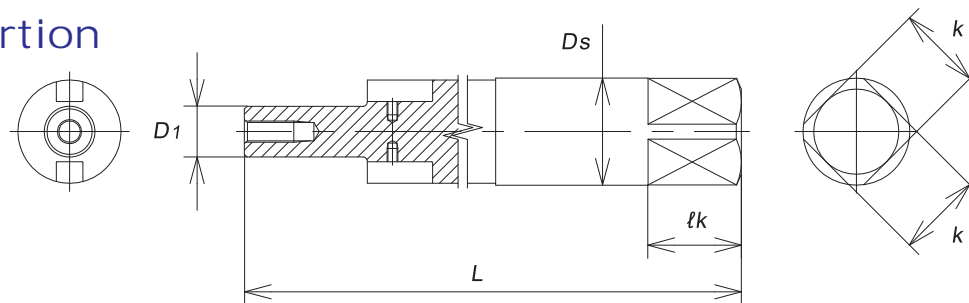

Code	Overall length after combined with arbor (mm)	L (mm)	Ds (mm)	D1 (mm)	k (mm)	lk (mm)	Stock
REAB22200	200	183	45	22	35	38	△
REAB22400	400	383					
REAB22600	600	583					

\*Each arbor includes all the following accessories.

## Accessory

### 1. Parallel key

Code	w (mm)	h (mm)	H1 (mm)	H2 (mm)	Applicable size	Stock
REPK30	30	10	8	4.5	M50~M80	△

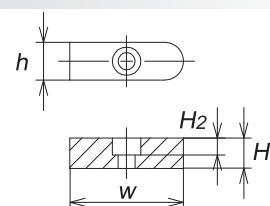

### 2. Flat washer

Code	D2 (mm)	d (mm)	t (mm)	Stock
REFW2228	28	10.5	2.5	△

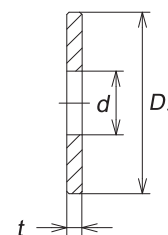

### 3. Bolt with hex hole (fixing screw for cutting edge portion)

Code	Size	s (mm)	ℓ (mm)	Stock
REBL0100	M10	8	25	△

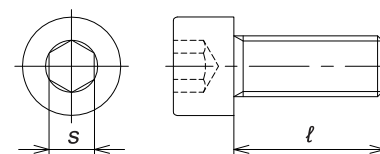

### Bolt with hex hole (fixing screw for parallel key)

Code	Size	s (mm)	ℓ (mm)	Stock
REBL4.0I	M4	3	8	△

△ = Made to Order

### Warning

- ◆ Tools may shatter. Wear cover or eye glasses to avoid injury during tapping.
- ◆ Tools may shatter. Use tools under the proper tapping condition.
- ◆ Never wear gloves during turning operations as the gloves may get caught with the tools.
- ◆ Wear safety shoes to avoid injuring yourself by the falling tools.
- ◆ On attaching tools to the machine, fasten firmly to avoid chattering and run-out.
- ◆ Fasten the workpieces firmly so that they never move during operation. Never use worn tools or damaged tools with chipping.
- ◆ Take a special care to fire trouble. High temperature during machining may cause fire.

Please note that specification may change without advance notice.